



Modüler Kalıp Sistemleri

Modular Formwork Systems







Panolar 40 kN/m² beton basınç dayanımına sahiptir.

Panoları insan gücüyle taşınabilir. Aynı zamanda bloklar halinde vinçle de taşınabilir.

Tek bir bağlantı elemanı ile panolar birbirlerine tek bir çekiç darbesiyle kolayca kilitletir.

Sistem temel olarak Sac/Plywood Yüzeyli Çelik Çerçevesiz Panolar, kuşaklar ve diğer çelik aksesuarlardan oluşur,

Aynı ölçüde kolon sayısının fazla olduğu projeler için tercih edilir,

Ek modifiye parçalar alınarak farklı projelere adapte edilebilir,

Panolar elle deplase edilebildiği gibi, kolay kullanılan pano kilitleri ile bir araya getirilerek vinçle taşınabilir,

Montaj kolaylığı, elle-vinçle deplase edilebilir olması ve sıva gerektirmemesi ile işçilik, zaman ve maliyetten tasarruf sağlar,

Konut, sanayi yapıları, alışveriş merkezleri gibi farklı alanlarda yüksek verimle kullanılabilir.

Panels have the concrete pressure resistance of 40 kN/m²

Formwork can be carried by hand. At the same time, it can be transported in blocks with crane.

With a single connection component, panels are locked each other with a single hammer strike.

The main components of the system are Steel/Plywood Surfaced Steel Framed Panels, Steel Walers and other steel accessories,
Preferable for the projects having mostly the same size columns,

The system can be adapted to various projects by using extra adaptation elements,

The panels can be displaced both by hand or by crane, combining each other by using u-clipses to form larger panels,

Provides cost, time and labour economy as being easy-to-assemble, crane displaceable and preventing the necessity for plastering,

Efficiently convenient to built residents, commercial and industrial facilities, shopping malls etc.

Ürün Kodu
Product Code

Ağırlık Kg
Weight Kg

Plywood Yüzeyle Modüler Pano / Plywood Surfaced Modular Panel

H / L

PK1001	08,50	90/15
PK1002	12,00	90/30
PK1003	16,30	90/45
PK1004	18,70	90/60
PK1005	28,10	90/90
PK1006	10,30	120/15
PK1007	14,00	120/30
PK1008	20,80	120/45
PK1009	22,80	120/60
PK1010	34,60	120/90
PK1011	12,80	150/15
PK1012	17,60	150/30
PK1013	25,70	150/45
PK1014	30,60	150/60
PK1015	42,50	150/90

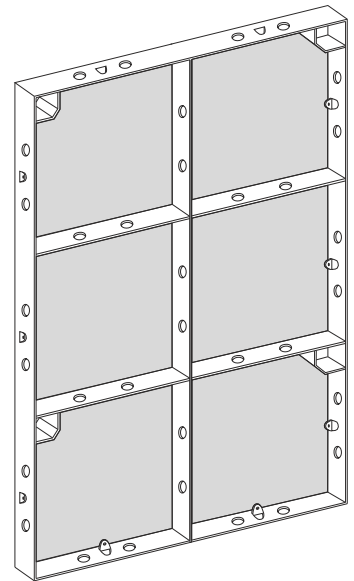
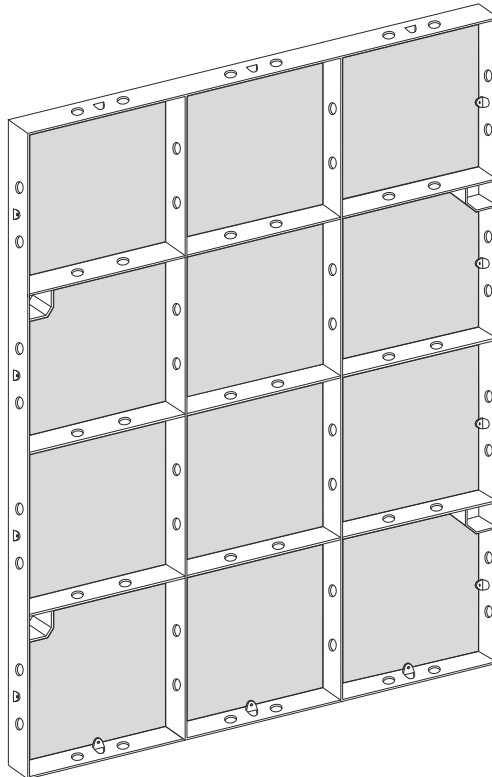
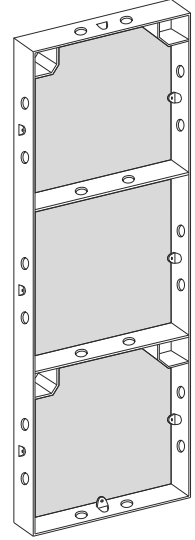
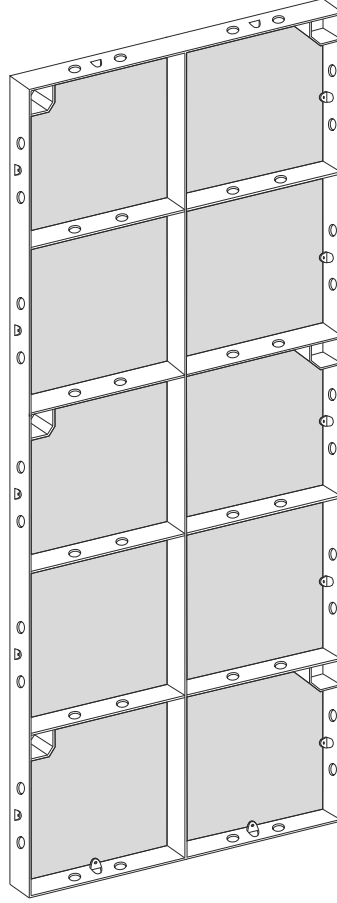

Ürün Kodu
Product Code

Ağırlık Kg
Weight Kg

Sac Yüzeyle Modüler Pano / Steel Surfaced Modular Panel

		H / L
PK1016	10,40	90/15
PK1017	14,10	90/30
PK1018	18,20	90/45
PK1019	20,80	90/60
PK1020	30,00	90/90
PK1021	12,40	120/15
PK1022	16,20	120/30
PK1023	22,60	120/45
PK1024	24,50	120/60
PK1025	36,30	120/90
PK1026	13,50	150/15
PK1027	19,50	150/30
PK1028	27,40	150/45
PK1029	32,60	150/60
PK1030	42,50	150/90

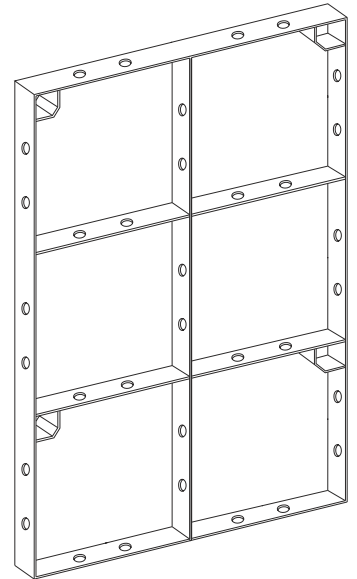
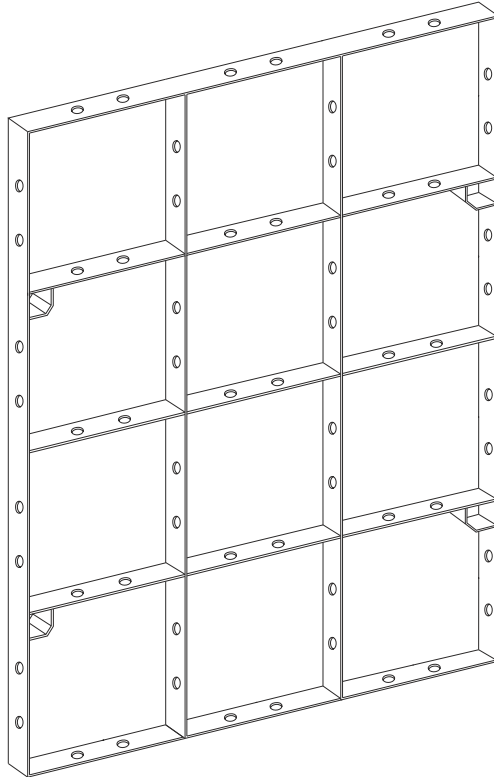
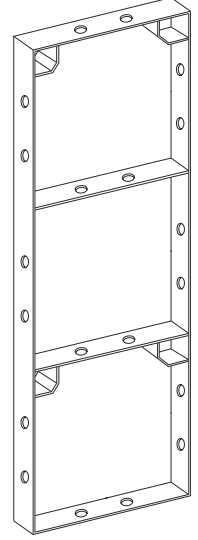
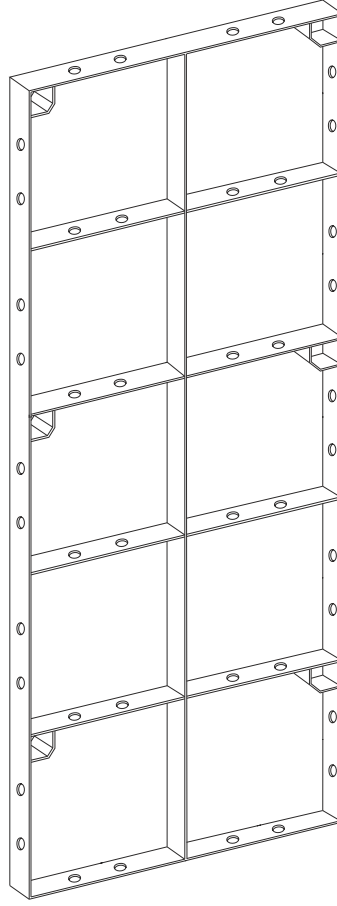

Ürün Kodu
Product Code

Ağırlık Kg
Weight Kg

Ayarlanabilir Plywood Yüzeyle Modüler Pano / Adjustable Plywood Surfaced Modular Panel

Ürün Kodu Product Code	Ağırlık Kg Weight Kg	H / L
PK1031	07,00	60/30
PK1032	09,50	60/40
PK1033	11,50	60/50
PK1034	14,00	60/60
PK1035	16,50	60/70
PK1036	18,50	60/80
PK1037	21,00	60/90
PK1038	23,50	60/100
PK1039	14,00	120/30
PK1040	19,00	120/40
PK1041	23,00	120/50
PK1042	28,00	120/60
PK1043	33,00	120/70
PK1044	37,20	120/80
PK1045	42,10	120/90
PK1046	47,00	120/100

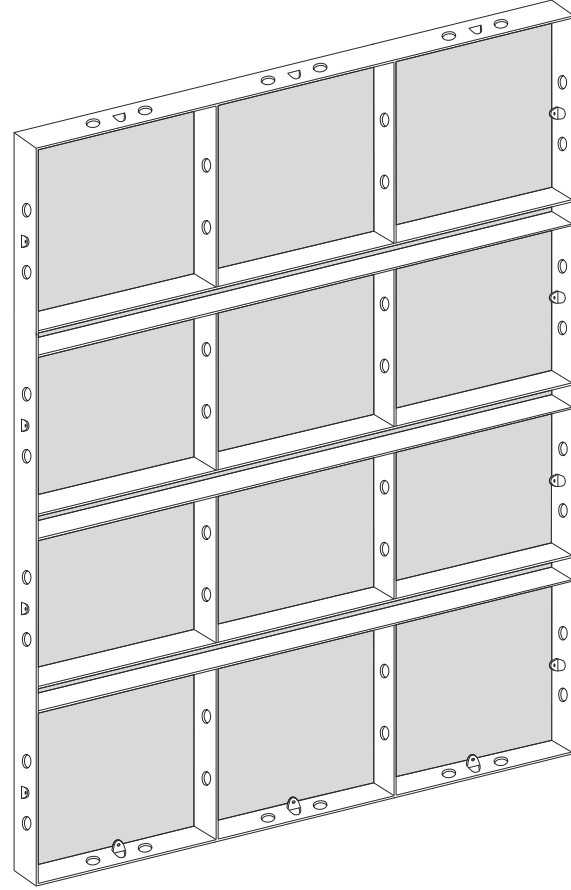

Ayarlanabilir Sac Yüzeyle Modüler Pano / Adjustable Steel Surfaced Modular Panel

Ürün Kodu Product Code	Ağırlık Kg Weight Kg	H / L
PK1047	07,00	60/30
PK1048	11,00	60/40
PK1049	14,00	60/50
PK1050	17,00	60/60
PK1051	20,00	60/70
PK1052	23,00	60/80
PK1053	26,00	60/90
PK1054	29,00	60/100
PK1055	16,00	120/30
PK1056	22,00	120/40
PK1057	28,00	120/50
PK1058	34,00	120/60
PK1059	40,00	120/70
PK1060	46,20	120/80
PK1061	52,10	120/90
PK1062	58,00	120/100

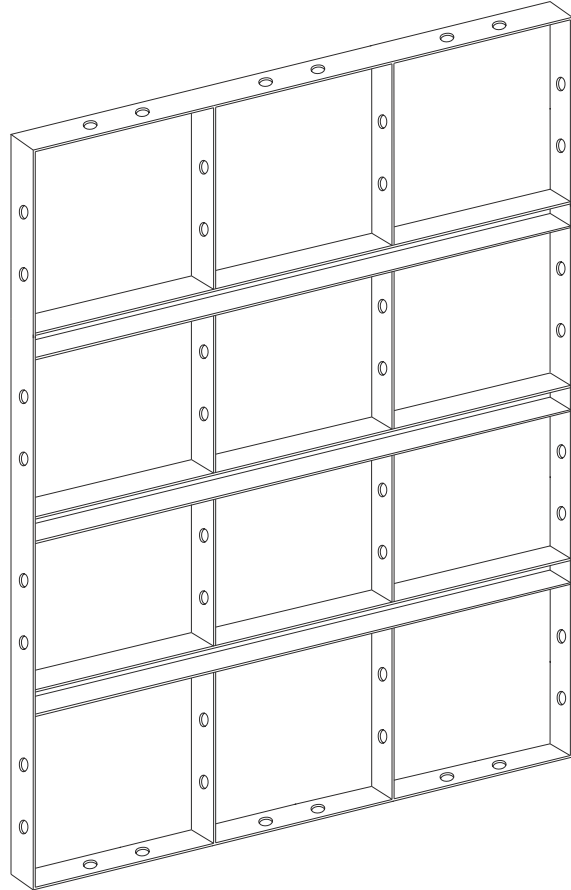

Ürün Kodu
Product Code

Ağırlık Kg
Weight Kg

Modüler Çelik Kuşak / Modular Steel Water

PK1063	15,00	100
PK1064	18,50	125
PK1065	22,30	150
PK1066	25,50	175
PK1067	30,00	200
PK1068	33,50	225
PK1069	37,50	250
PK1070	41,50	275
PK1071	45,00	300

L

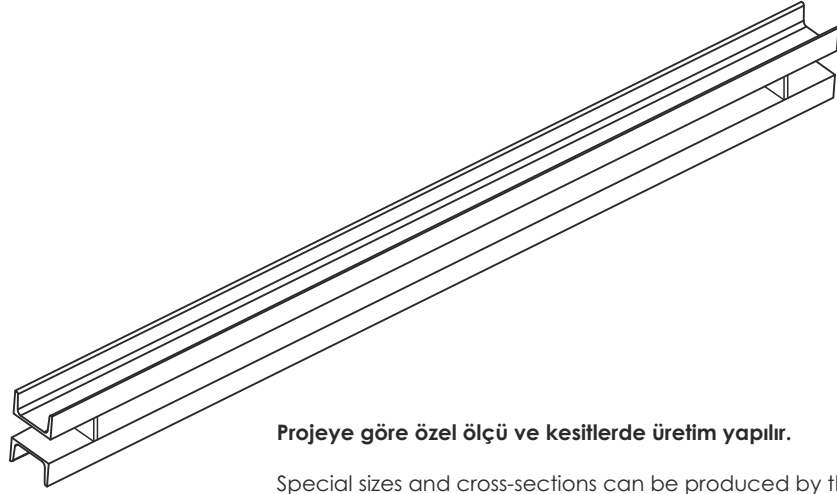

Projeye göre özel ölçü ve kesitlerde üretim yapılır.

Special sizes and cross-sections can be produced by the project

İç Köşe Pano / Inner Corner Panel

PK1072	09,00	60/15/15
PK1073	13,50	90/15/15
PK1074	18,00	120/15/15
PK1075	22,50	150/15/15
PK1076	27,00	180/15/15
PK1077	11,00	60/20/20
PK1078	16,50	90/20/20
PK1079	21,00	120/20/20
PK1080	25,40	150/20/20
PK1081	33,00	180/20/20

H / L / L

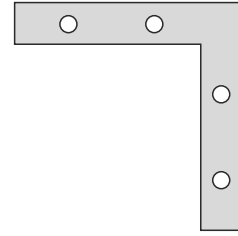
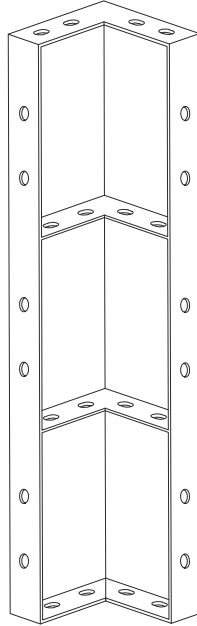

Mafsallı İç Köşe Pano / Swivel Inner Corner Panel

PK1082	09,00	60/15/15
PK1083	13,50	90/15/15
PK1084	18,00	120/15/15
PK1085	22,50	150/15/15
PK1086	27,00	180/15/15
PK1087	11,00	60/20/20
PK1088	16,50	90/20/20
PK1089	21,00	120/20/20
PK1090	25,40	150/20/20
PK1091	33,00	180/20/20

H / L / L

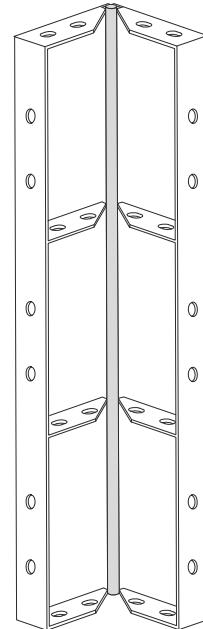
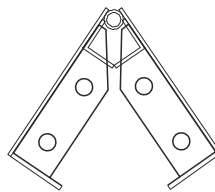
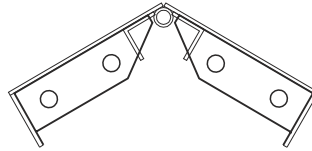

Ürün Kodu
Product Code

Ağırlık Kg
Weight Kg

Dış Köşe Elemanı / Outer Corner Connector

H / L / L

PK1092	04,50
PK1093	06,00
PK1094	07,50
PK1095	09,00
PK1096	10,50
PK1097	12,00
PK1098	14,20

60/7/7
90/7/7
120/7/7
150/7/7
180/7/7
210/7/7
240/7/7

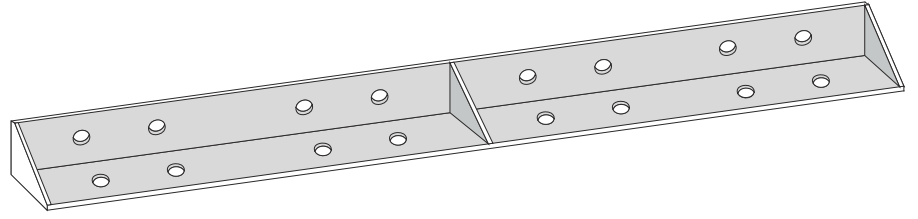

Tırmanır Pano / Climbing Panel

H / L

PK1099	27,00
PK1100	36,00

180/10
180/20

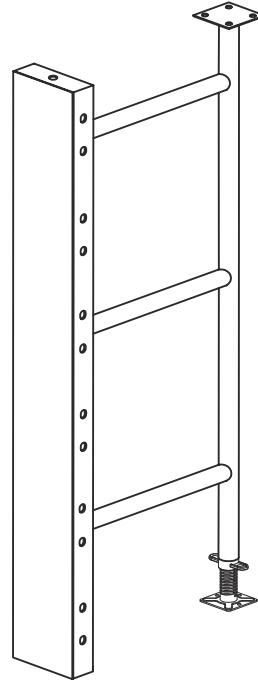

Dairesel Kolon Kalıp Modülü / Circular Column Formwork Module

Ø

PK1101	040,5	30
PK1102	045,8	35
PK1103	053,4	40
PK1104	058,7	45
PK1105	062,1	50
PK1106	067,6	55
PK1107	072,3	60
PK1108	084,5	70
PK1109	091,1	80
PK1110	110,0	90
PK1111	146,1	100
PK1112	158,0	110
PK1113	170,0	120
PK1114	182,0	130
PK1115	194,0	140
PK1116	208,1	150
PK1117	222,3	160

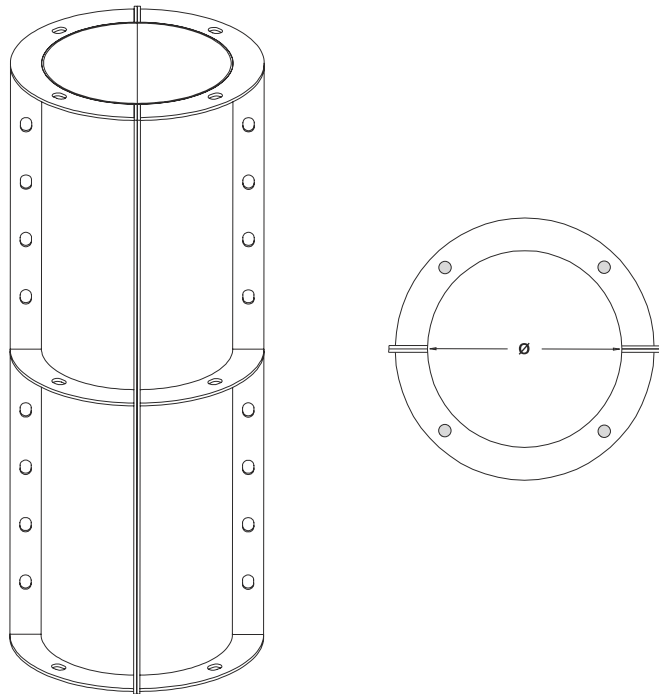

Ürün Kodu
Product Code

Ağırlık Kg
Weight Kg

Pano Kilidi / Panel Clamp

PK1118

00,66

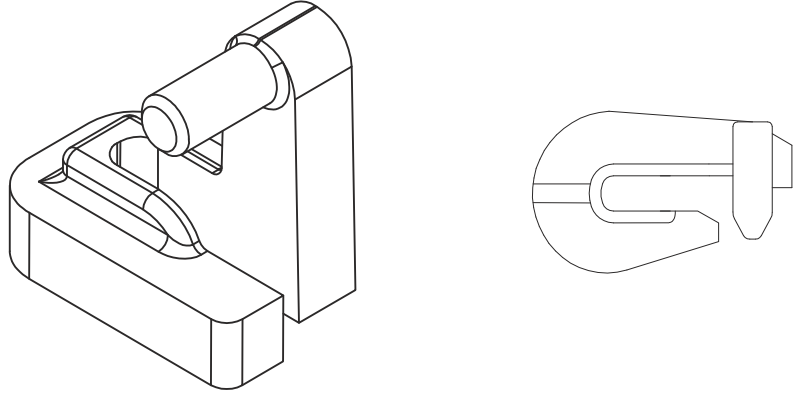

Ankraj Mili / Anchoring Bar

PK0028

01,50

L

100

PK0029

01,90

125

PK0030

02,30

150 Ø17

PK0031

02,60

175

PK0032

03,00

200

PK0033

03,40

225

PK0034

03,80

250

PK0035

03,00

300 Ø24

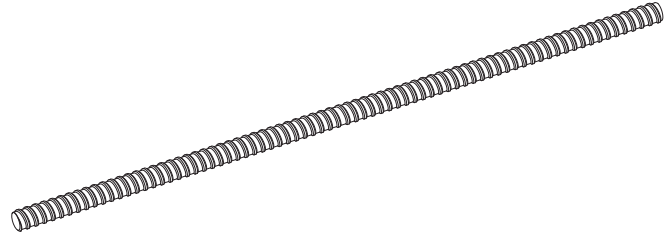

Ayna / Plate

PK0036

00,50

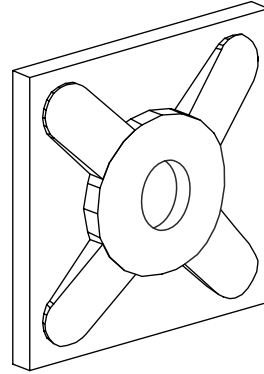

Tie Rod Somunu / Waler Wing Nut

PK0037

00,50

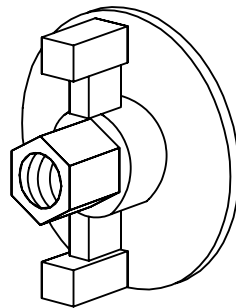

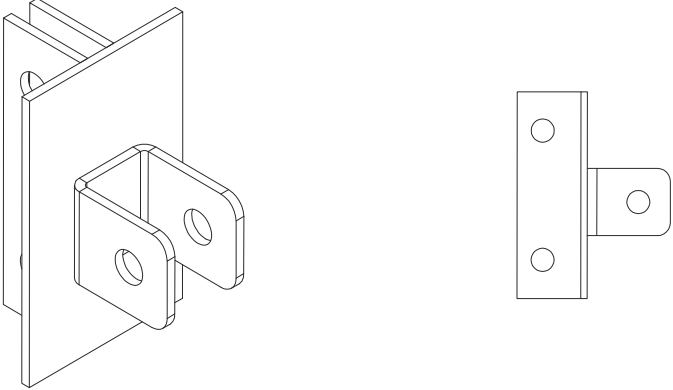
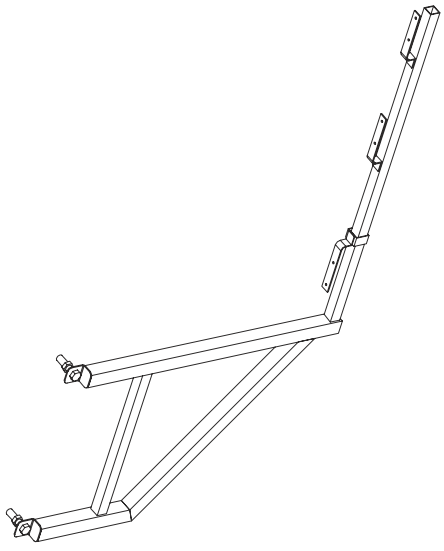
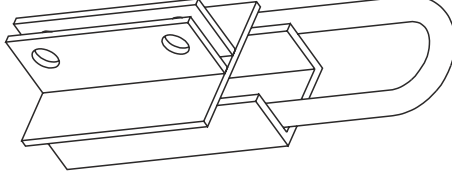
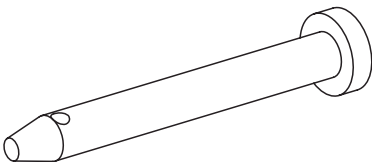
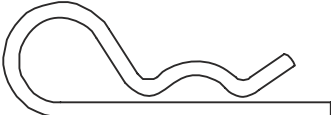
Ürün Kodu Product Code	Ağırlık Kg Weight Kg	
PK1119	01,82	Payanda Başlığı / Push Pull Prop Head 
PK1120	08,20	Çalışma Konsolu / Walkway Bracket <p>İdeal kullanım açıklığı 1,25 metredir. Allowable spacing is 1,25 meter.</p> 
PK1121	03,00	Vinç Kulpu / Crane Splice 
PK0042	00,40	Pim / Pin <p>Payandaların kafalara birleşimini sağlar. For connecting push-pull props with heads.</p> 
PK0043	00,03	Kopilya / Cotter Pin 

Ürün Kodu
Product Code

Ağırlık Kg
Weight Kg

Çift Kollu Payanda / Push Pull Prop

PK0044	23,20
PK0045	25,90
PK0046	31,20
PK0047	34,40
PK0048	38,00

H-Min H-Max

165	225
225	285
300	360
330	390
435	495

H : Kalıp Yüksekliği

6m ve üzeri yüksek perdelerde kalıbın şaküle alınması için payanda bağlantı başlığı ve payanda tabanı ile kullanılır

6m and higher panels used with push-pull prop head and base plate

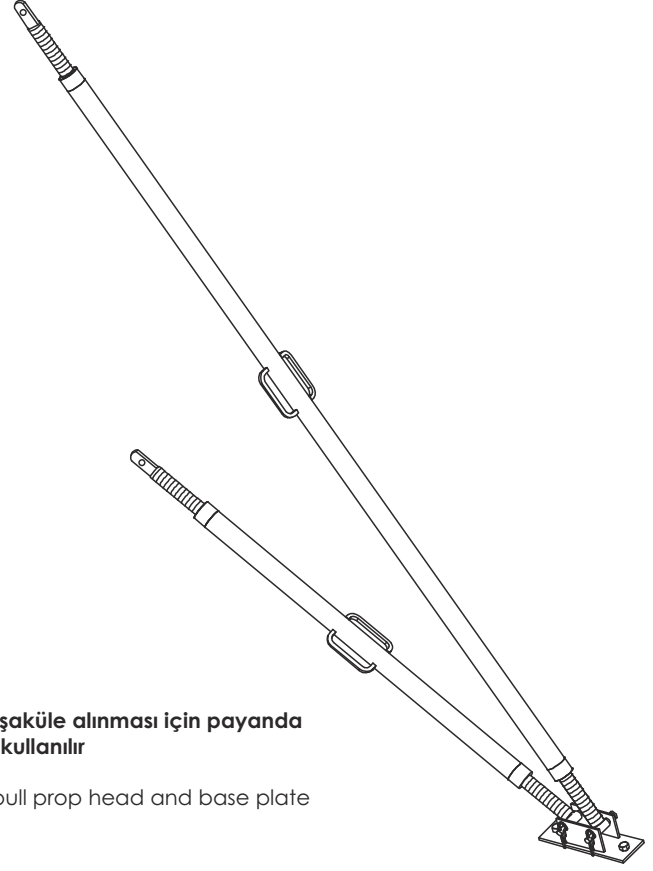

Payanda tabanı Tekli / Base Plate For Single

PK0049 01,80

Bir adet pim ve bir adet kopilya ile kullanılır

Used with one pins and one detent pins

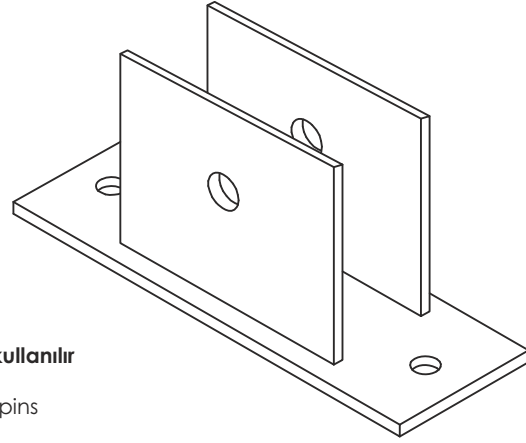

Payanda Tabanı ikili / Base plate For Double

PK0050 03,50

İki adet pim ve iki adet kopilya ile kullanılır

Used with two pins and two detent pins

